

Artemide®

STELLAR NEBULA TABLE

design
BIG

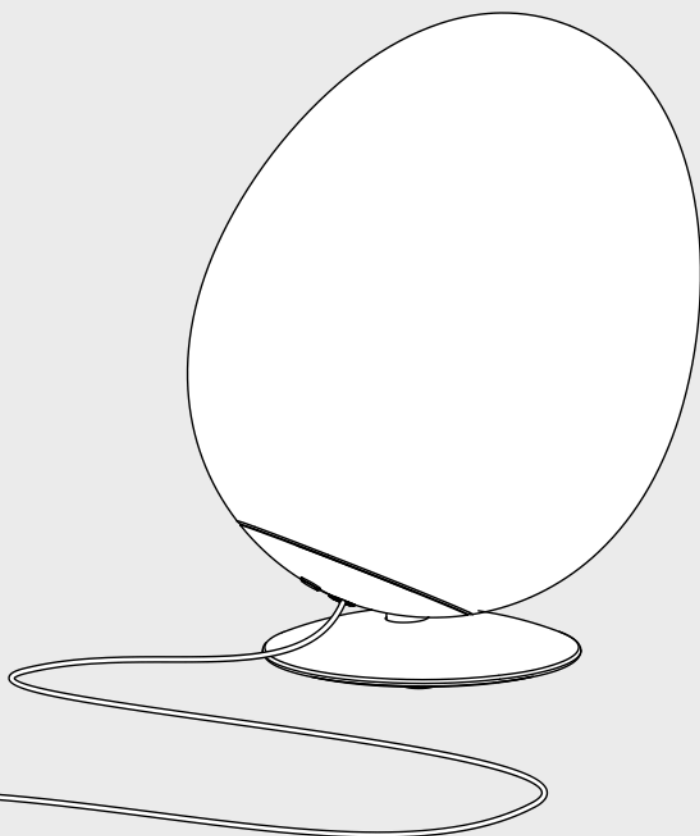



i

FOR USA/
CANADA ONLY

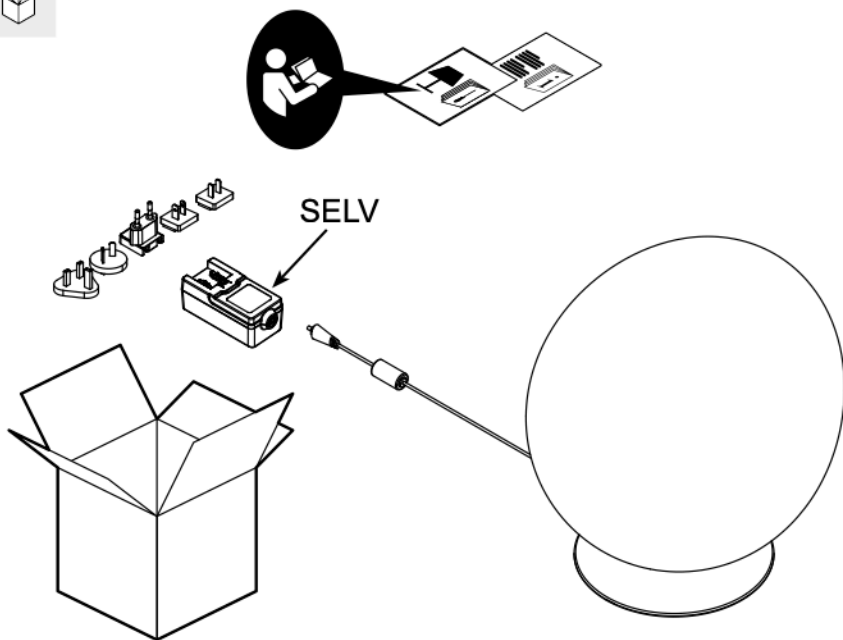
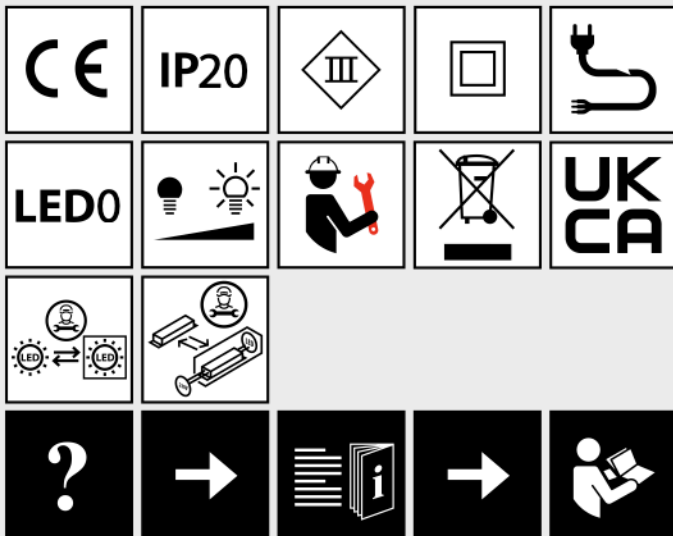

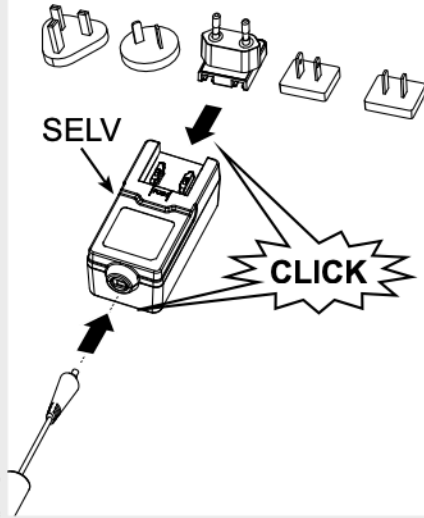
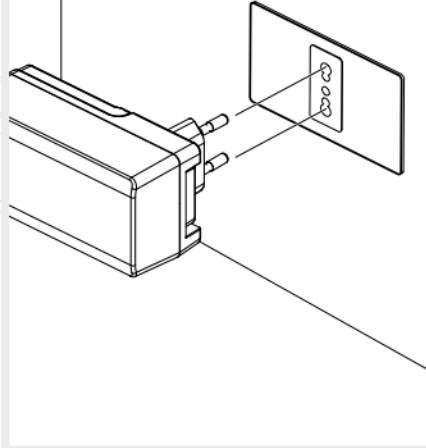
1**2**

**FOR USA/
CANADA ONLY**

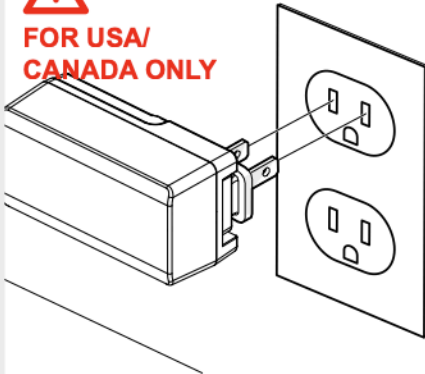

IMPORTANT SAFETY INSTRUCTIONS

This portable lamp has a polarized plug (one blade is wider than the other one).

As a safety feature, this plug will fit in a polarized outlet only one way. If the plug does not fit fully in the outlet, reverse the plug. If it still does not fit, contact a qualified electrician. Never use with an extension cord unless plug can be fully inserted. Do not attempt to defeat this safety feature.

INSTRUCTIONS IMPORTANTES DE SECURITE

Cette lampe portable a une fiche polarisée (une lame est plus grande que l'autre). Comme caractéristique pour réduire les risques de choc électrique, cette fiche n'engage qu'une prise polarisante. Si la fiche n'engage pas complètement la prise, il faut la renverser; si elle ne s'engage toujours pas, mettez vous en rapport avec un électricien qualifié. Ne jamais utiliser avec un prolongateur si la fiche ne pénètre pas complètement. Ne pas changer la fiche.

3

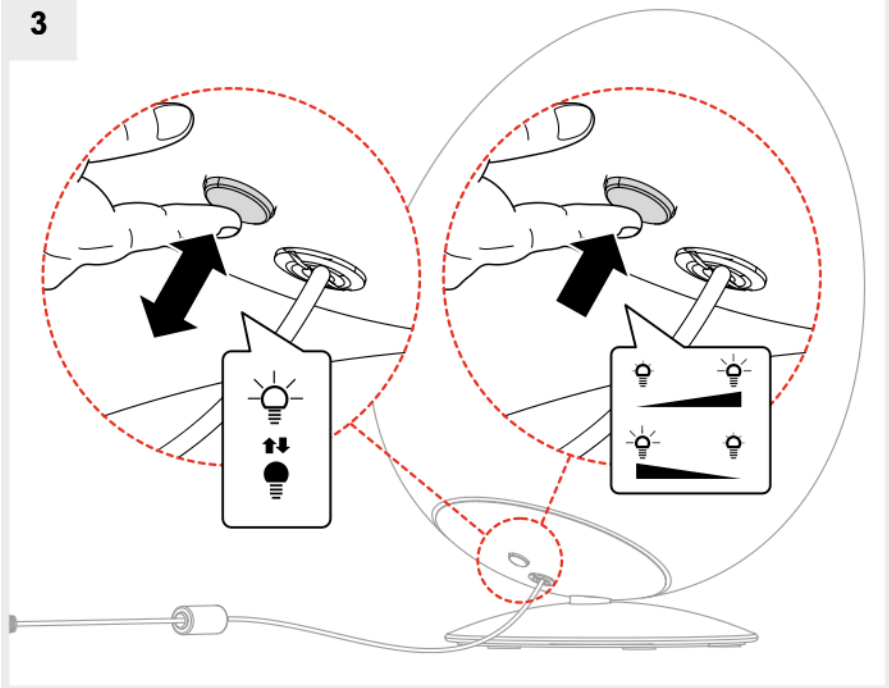

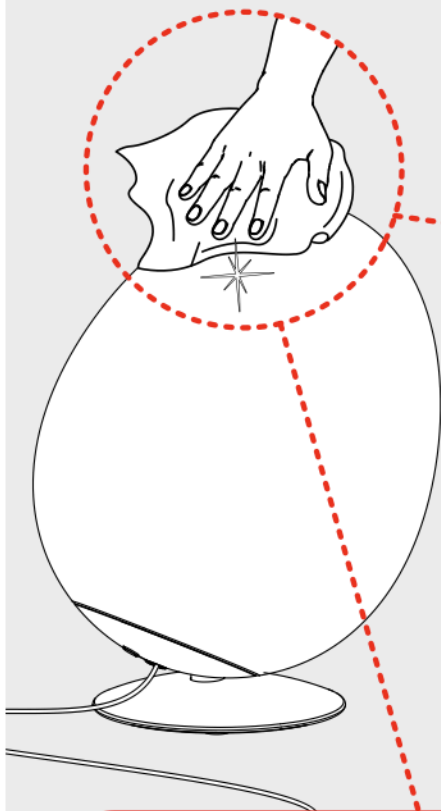

UTILIZZARE SOLO PANNI IN MICROFIBRA ANTI-GRAFFIO

USE ONLY ANTI-SCRATCH MICROFIBRE CLOTH

**UTILISER UNIQUEMENT DES CHIFFONS EN MICROFIBRE
RÉSISTANTS AUX RAYURES**

**UTILICE ÚNICAMENTE PAÑOS DE MICROFIBRA
RESISTENTES A LOS ARAÑAZOS**

NUR KRATZFESTE MIKROFASERTÜCHER VERWENDEN

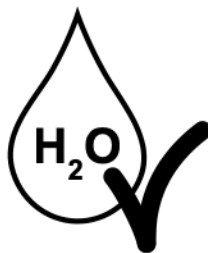
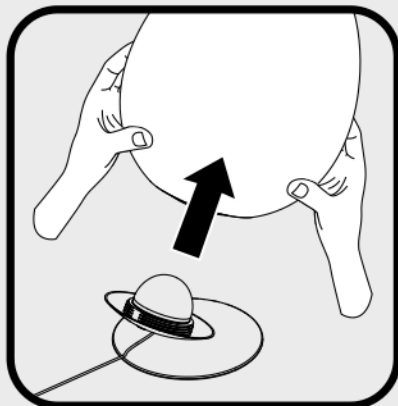
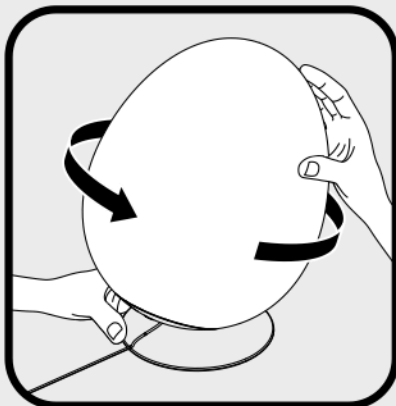

**UTILIZZARE SOLO PANNI IN
MICROFIBRA ANTI-GRAFFIO**

**USE ONLY ANTI-SCRATCH
MICROFIBRE CLOTH**

**UTILISER UNIQUEMENT DES
CHIFFONS EN MICROFIBRE
RÉSISTANTS AUX RAYURES**

**UTILICE ÚNICAMENTE PAÑOS
DE MICROFIBRA RESISTENTES
A LOS ARAÑAZOS**

**NUR KRATZFESTE
MIKROFASERTÜCHER
VERWENDEN**

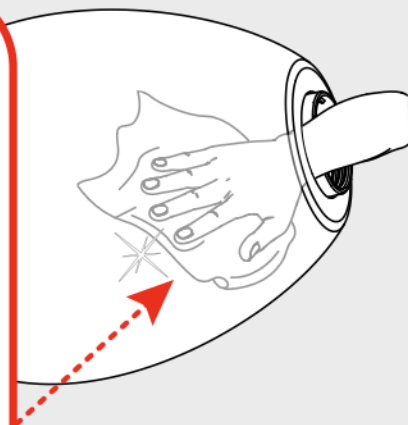

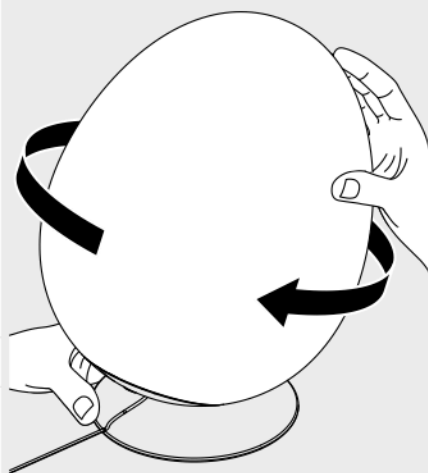
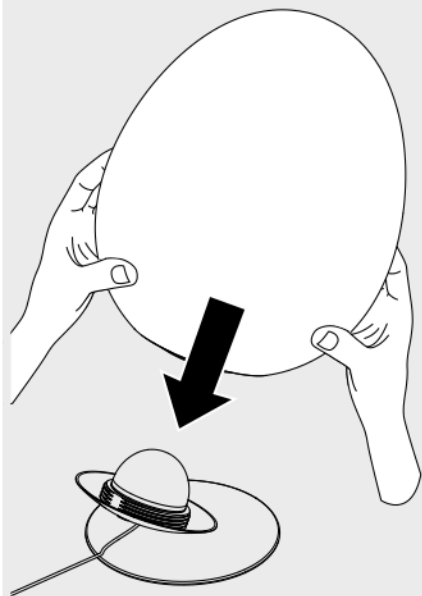

Artemide®

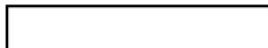

Artemide

via Bergamo, 18
20006 Pregnana M.se (MI)
ITALIA

tel. +39 02 935 181
fax +39 02 935 90 254
fax +39 02 935 90 496

www.artemide.com

VAT IT00846890150

Artemide Inc.

250 Karin Lane
Hicksville, NY 11801

tel. 631 694 9292
Toll Free 1-877-Art-9111
Fax 631 694 9275

www.artemide.net

Artemide Ltée/Ltd.

11105 rue Renaude Lapointe
Montréal, Québec H1J 2T4

Tel. 514 323 6537
Toll Free 888 777 2783
Fax 514 323 8864

www.artemide.net

cod. Y513001712B