

Ita OS3-OS4

OEO Studio

2025

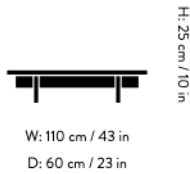



# Ita OS3

## OEO Studio

### 2025

#### Product description

Coffee table

#### Environment

Indoor

#### Material

MDF, oak veneer, solid oak. This product has not been treated with any biocides.

#### Production process

MDF sheets are cut using a CNC machine and covered with an oak veneer and solid oak edges. The components are then sanded smooth and coated in a water-based lacquer for protection.

#### Dimensions

W: 110 cm / 43 in

H: 25 cm / 10 in

D: 60 cm / 23 in

#### Weight

19.5 kg

#### Strength, durability and safety testing

EN 15372 Level 2 (Tables)

BIFMA x5.5

#### Certifications



FSC® Mix 70%

#### Gliders

Plastic gliders as standard

#### Impact

- Flat-packed, helping optimise shipping and delivery.
- Uses water based lacquer, safer for indoor air quality.
- Uses FSC® certified wood, supporting responsible management of the world's forests.
- Designed for disassembly, making it easier to repair, renovate, pass on, and responsibly recycle at end of life.

#### Manufacturer

Produced in Poland by Fabryka Mebli Zabroccy Sp. z o.o.

#### Cleaning Instructions

Please see our [Maintenance & Care instructions here](#)

#### Stock item

Oak, Dark Stained Oak



→ Oak



→ Dark Stained Oak

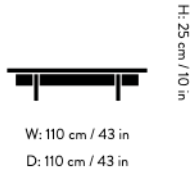

# Ita OS4

## OEO Studio

### 2025

#### Product description

Coffee table

#### Environment

Indoor

#### Material

MDF, oak veneer, solid oak. This product has not been treated with any biocides.

#### Production process

MDF sheets are cut using a CNC machine and covered with an oak veneer and solid oak edges. The components are then sanded smooth and coated in a water-based lacquer for protection.

#### Dimensions

W: 110 cm / 43 in  
H: 25 cm / 10 in  
D: 110 cm / 43 in

#### Weight

33.5 kg

#### Strength, durability and safety testing

EN 15372 Level 2 (Tables)  
BIFMA x5.5

#### Certifications



FSC® Mix 70%

#### Gliders

Plastic gliders as standard

#### Impact

- Flat-packed, helping optimise shipping and delivery.
- Uses water based lacquer, safer for indoor air quality.
- Uses FSC® certified wood, supporting responsible management of the world's forests.
- Designed for disassembly, making it easier to repair, renovate, pass on, and responsibly recycle at end of life.

#### Manufacturer

Produced in Poland by Fabryka Mebli Zabroccy Sp. z o.o.

#### Cleaning Instructions

Please see our [Maintenance & Care instructions here](#)

#### Stock item

Oak, Dark Stained Oak

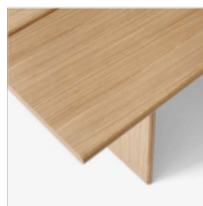

→ Oak

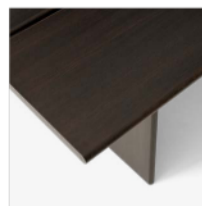

→ Dark Stained Oak

# Recycling & Disassembly

Ita OS3-OS4

## RECYLING

The Ita coffee table has been made to last and we hope it will serve you for many years. The table is made from wood and can be easily separated into its components and delivered to a suitable recycling depot.

## SPARE PARTS

To purchase spare parts for your Ita coffee table, please write to our sales support team at [info@andtradition.com](mailto:info@andtradition.com) with your query.

## 5 YEAR WARRANTY

&Tradition provides a 5-year warranty with every Ita coffee table, which covers faults present at the time of purchase, or those which have occurred as a result of a manufacturing defect. The warranty is valid from the date stated on the original invoice.

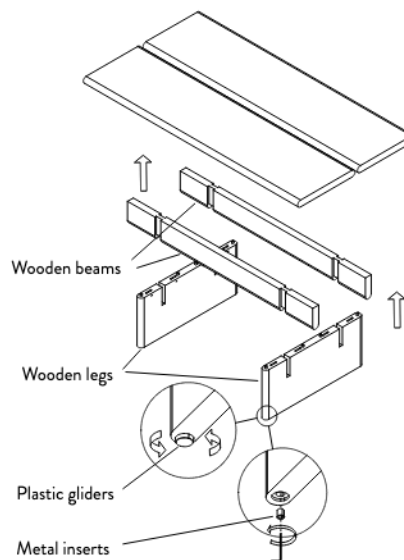
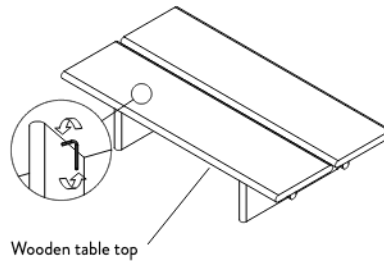

## DISASSEMBLY

**Please follow these five steps to disassemble the Ita coffee table  
60x110 cm / 110x110 cm**

1. To separate each component of the Ita coffee table, you first need to open the connectors. Insert an Allen key into each connector located under the table top and turn it counterclockwise until it stops. If done correctly, you should be able to lift the table top without resistance. If not, ensure that the connectors are fully opened.
2. Separate all components from each other by lifting them apart. Ensure you have an additional person to perform this action safely. Start by removing the table top, then continue to remove one leg at a time. Finally, detach the beams from the second leg.
3. Remove the gliders from under the feet by unscrewing them counterclockwise. Next, use an Allen key to remove the threaded inserts.

# Recycling & Disassembly

Ita OS3-OS4

---

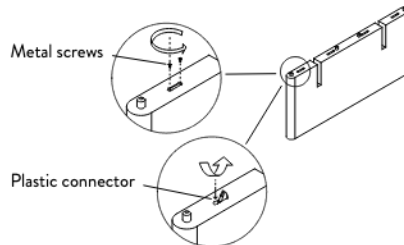

## DISASSEMBLY

4. Remove the plastic connectors on both the legs and underneath the tabletop. To do this, remove the two screws, then carefully push one side of the connector with a tool or finger to rotate/slide it out of the pocket as shown.

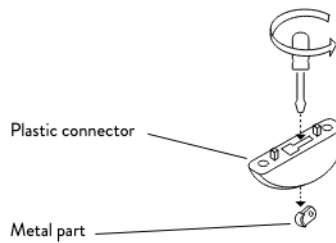

5. Finally, to separate both the plastic and metal from the connectors, use a flat-head screwdriver and place it into the narrow end of the opening on the flat side of the connector. Rotate the screwdriver slightly to open the plastic, allowing you to pull out the metal part from the underside of the connector.