

Sestessina led



9 cm
3 1/2"

24cm
9 1/2"

17,5 cm
6 3/4"





luminaire	
materials	aluminium
environment	interiors
mounting location	wall
emission	indirect light
weight	1,0 kg
voltage	230V
ballast	integrated electronic dimmable
dimming	phase-cut / casambi integrated / not dimmable (on-off version)
insulation class	1
IP classification	IP20
certifications	CE UK CA
design	Luta Bettonica, Mario Melocchi, 2009-2013

light source	
source	LED
number of LED	1
power	20W
CRI	80 - 95
luminous flux	2.000 lm (CRI80) - 1.700 lm (CRI95)
colour temperature	2.700K
	available at 3.000K / 3.500K / 4.000K
	for orders ≥ 5 pieces

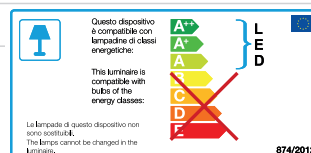
energy label



finish and code	
	
white CRI80	white CRI95
cod 219	cod 219H
cod C219	cod C219H
cod 269	cod 269H
	phase-cut dimmable casambi integrated on-off

versions	
	
Sestessina led	Sestessina alogena
	
Sestessa led	Sestessa alogena
	
Sestessa maxi led	

CINI & NILS

Sestessa led



33 cm
13"



24 cm
9 1/2"

11 cm
4 1/4"





luminaire	
materials	aluminium
environment	interiors
mounting location	wall
emission	indirect light
weight	1,7 kg
voltage	230V
ballast	integrated electronic dimmable
dimming	phase-cut / casambi integrated / not dimmable (on-off version)
insulation class	1
IP classification	IP20
certifications	CE UK CA
design	Luta Bettonica, Mario Melocchi, 2009-2013

light source	
source	LED
number of LED	1
power	20W
CRI	80 - 95
luminous flux	2.900 lm (CRI80) - 1.850 lm (CRI95)
colour temperature	2.700K
	available at 3.000K / 3.500K / 4.000K
	for orders ≥ 5 pieces

energy label



finish and code	
	
white CRI80	white CRI95
cod 232	cod 232H
cod C232	cod C232H
cod 272	cod 272H
	phase-cut dimmable
	casambi integrated
	on-off

versions	
	
Sestessa led	Sestessa alogena
	
Sestessina led	Sestessina alogena
	
Sestessa maxi led	

CINI & NILS

Sestessa maxi led



11 cm
4 1/4"

55 cm
21 5/8"

24,5 cm
9 5/8"





luminaire	
materials	aluminium
environment	interiors
mounting location	wall
emission	indirect light
weight	3,6 kg
voltage	230V
ballast	integrated electronic dimmable
dimming	phase-cut / casambi integrated
insulation class	1
IP classification	IP20
certifications	CE UK CA
design	Luta Bettonica, Mario Melocchi, 2009-2013

light source	
source	LED
number of LED	1
power	39W
CRI	80 - 95
luminous flux	5.000 lm (CRI80) - 3.300 lm (CRI95)
colour temperature	2.700K
	available at 3.000K / 3.500K / 4.000K
	for orders ≥ 5 pieces

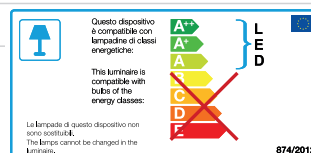
energy label



finish and code	
	
white CRI80 cod 218 cod C218	white CRI95 cod 218H cod C218H
	phase-cut dimmable casambi integrated

versions	
	
Sestessa led	Sestessa alogena
	
Sestessina led	Sestessina alogena
	
Sestessa maxi led	

CINI & NILS

Sestessa plafone led

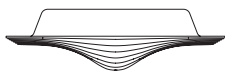

15 cm
5 7/8"

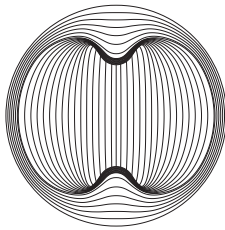

Ø 50 cm
Ø 19 3/4"





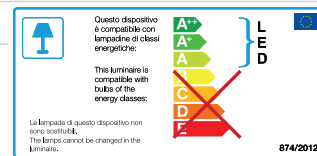

luminaire	
materials	aluminium
environment	interiors
mounting location	ceiling
emission	indirect light
weight	6,7 kg
voltage	230V
ballast	2 x integrated electronic dimmable
dimming	phase-cut / casambi integrated
insulation class	1
IP classification	IP20
certifications	CE UK CA
design	Luta Bettonica, Mario Melocchi, 2009-2013

light source	
source	LED
number of LED	2
power	2x26W
CRI	95
luminous flux	2x2.400 lm
colour temperature	2.700K
	available at 3.000K / 3.500K / 4.000K
	for orders ≥ 5 pieces

energy label



finish and code	
white	phase-cut dimmable
cod 237H	casambi integrated
cod C237H	

versions			
			
Sestessa plafone led	Sestessa semincasso led	Sestessa sospesa led	Sestessa cabrio led

Sestessa semincasso led

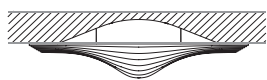

8 cm
3 1/8"

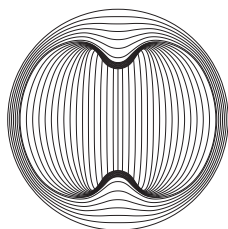

Ø 50 cm
Ø 19 3/4"





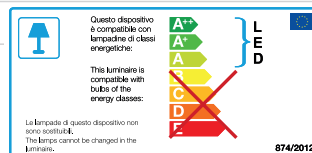

luminaire	
materials	aluminium
environment	interiors
mounting location	ceiling
emission	indirect light
weight	4,4 kg
voltage	230V
ballast	2 x integrated electronic dimmable
dimming	phase-cut / casambi integrated
insulation class	1
IP classification	IP20
certifications	CE UK CA
design	Luta Bettonica, Mario Melocchi, 2009-2013

light source	
source	LED
number of LED	2
power	2x26W
CRI	95
luminous flux	2x2.400 lm
colour temperature	2.700K
	available at 3.000K / 3.500K / 4.000K
	for orders ≥ 5 pieces

energy label



finish and code	
 white cod 236H cod C236H	phase-cut dimmable casambi integrated

versions			
			
Sestessa plafone led	Sestessa semincasso led	Sestessa sospesa led	Sestessa cabrio led

Sestessa sospesa led

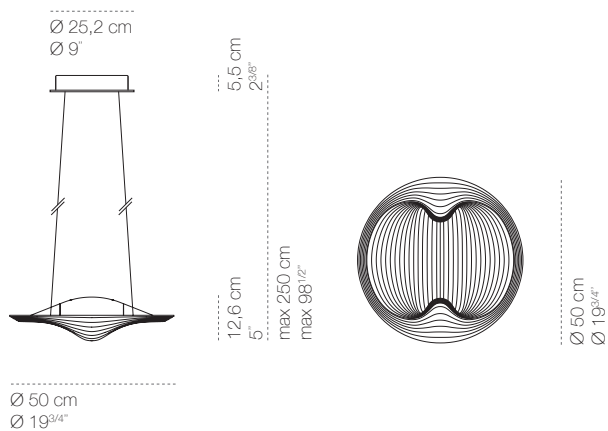

luminaire	
materials	aluminium
environment	interiors
mounting location	ceiling
emission	indirect light
weight	5,9 kg
voltage	230V
ballast	2 x integrated electronic dimmable
dimming	phase-cut / casambi integrated
insulation class	1
IP classification	IP20
certifications	CE UK CA
design	Luta Bettonica, Mario Melocchi, 2009-2013

light source	
source	LED
number of LED	2
power	2x26W
CRI	95
luminous flux	2x2.400 lm
colour temperature	2.700K
	available at 3.000K / 3.500K / 4.000K
	for orders ≥ 5 pieces

energy label

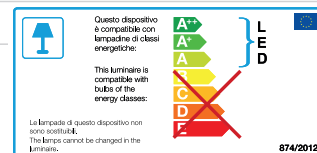

finish and code	
white	phase-cut dimmable
cod 235H	casambi integrated
cod C235H	

versions			
Sestessa plafone led	Sestessa semincasso led	Sestessa sospesa led	Sestessa cabrio led

Sestessa cabrio led

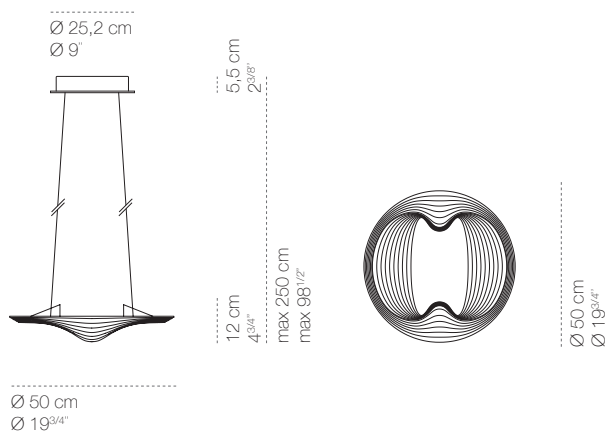

luminaire	
materials	aluminium
environment	interiors
mounting location	ceiling
emission	diffuse and indirect light
weight	4,6 kg
voltage	230V
ballast	2 x integrated electronic dimmable
dimming	phase-cut / casambi integrated
insulation class	1
IP classification	IP20
certifications	CE UK CA
design	Luta Bettonica, Mario Melocchi, 2009-2013

light source	
source	LED
number of LED	2
power	2x26W
CRI	95
luminous flux	2x2.400 lm
colour temperature	2.700K
	available at 3.000K / 3.500K / 4.000K
	for orders ≥ 5 pieces

energy label

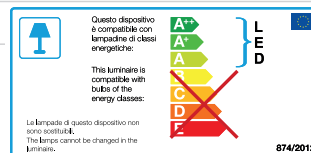

finish and code	
white	phase-cut dimmable
cod 234H	casambi integrated
cod C234H	

versions			
Sestessa plafone led	Sestessa semincasso led	Sestessa sospesa led	Sestessa cabrio led

Sestessa terra led

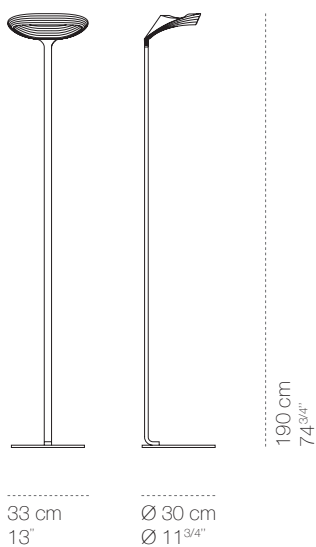



luminaire	
materials	aluminium
environment	interiors
mounting location	floo
emission	indirect and diffuse light
weight	9,0 kg
voltage	230V
ballast	integrated electronic dimmable
dimmer	electronic in line
insulation class	1
plug	european 2 poles
IP classification	IP20
certifications	CE UK CA
design	Luta Bettonica, Mario Melocchi, 2009-2013

light source	
source	LED
number of LED	1
power	39W
CRI	80 - 95
luminous flux	3.900 lm (CRI80) - 2.850 lm (CRI95)
colour temperature	2.700K
	available at 3.000K / 3.500K / 4.000K
	for orders ≥ 5 pieces

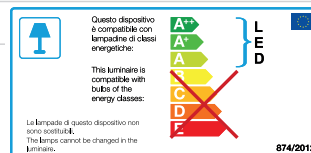
energy label



finish and code	
	
white CRI80	white CRI95
cod 221	cod 221H
cod 222	cod 222H
	swiss plug

versions	
	
Sestessa terra alogena	Sestessa terra led